

## 300mW, NPN Small Signal Transistor

### FEATURES

- Low power loss, high efficiency
- Ideal for automated placement
- High surge current capability
- Moisture sensitivity level: level 1, per J-STD-020
- Compliant RoHS
- Halogen-free according to IEC 61249-2-21

### APPLICATIONS

- Switching mode power supply (SMPS)
- Adapters
- Lighting application
- On-board DC/DC converter

### MECHANICAL DATA

- Case: SOT-23
- Molding compound meets UL 94 V-0 flammability rating
- Terminal: Matte tin plated leads, solderable per J-STD-002
- Meet JESD 201 class 1A whisker test
- Weight: 8mg (approximately)

KEY PARAMETERS		
PARAMETER	VALUE	UNIT
$V_{CBO}$	50	V
$V_{CEO}$	45	V
$V_{EBO}$	5	V
$I_C$	500	mA
$h_{FE}$	250-600	
Package	SOT-23	
Configuration	Single die	

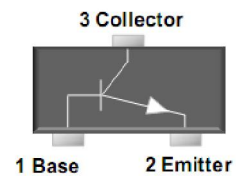

ABSOLUTE MAXIMUM RATINGS ( $T_A = 25^\circ\text{C}$ unless otherwise noted)					
PARAMETER	SYMBOL	BC817-16	BC817-25	BC817-40	UNIT
Marking code on the device		6A	6B	6C	
Power dissipation	$P_D$	300			mW
Collector-base voltage, emitter open	$I_C = 10 \mu\text{A}, I_E = 0$	$V_{CBO}$	50		V
Collector-emitter voltage, base open	$I_C = 10 \text{mA}, I_B = 0$	$V_{CEO}$	45		V
Emitter-base voltage, collector open	$I_E = 1 \mu\text{A}, I_C = 0$	$V_{EBO}$	5		V
Collector current, dc	$I_C$	500			mA
Junction temperature	$T_J$	-55 to +150			$^\circ\text{C}$
Storage temperature	$T_{STG}$	-55 to +150			$^\circ\text{C}$

<b>ELECTRICAL SPECIFICATIONS</b> ( $T_A = 25^\circ\text{C}$ unless otherwise noted)						
<b>PARAMETER</b>	<b>CONDITIONS</b>	<b>SYMBOL</b>	<b>MIN</b>	<b>TYP</b>	<b>MAX</b>	<b>UNIT</b>
Collector cutoff current, emitter open	$V_{CB} = 45\text{ V}, I_E = 0$	$I_{CBO}$	-	-	0.1	$\mu\text{A}$
Emitter cutoff current, collector open	$V_{EB} = 4\text{ V}, I_C = 0$	$I_{EBO}$	-	-	0.1	$\mu\text{A}$
DC current gain	$V_{CE} = 1\text{ V}, I_C = 100\text{ mA}$	BC817-16	100	-	250	
		BC817-25	160	-	400	
		BC817-40	250	-	600	
Collector-emitter saturation voltage	$I_C = 500\text{ mA}, I_B = 50\text{ mA}$	$V_{CE(sat)}$	-	-	0.7	V
Base-emitter saturation voltage	$I_C = 500\text{ mA}, I_B = 50\text{ mA}$	$V_{BE(sat)}$	-	-	1.2	V
Transition frequency	$V_{CE} = 5\text{ V}, I_C = 10\text{ mA}, f = 100\text{ MHz}$	$f_T$	100	-	-	MHz

<b>ORDERING INFORMATION</b>		
<b>ORDERING CODE</b> (Note1, 2)	<b>PACKAGE</b>	<b>PACKING</b>
BC817-XX RF	SOT-23	3K / 7" Reel
BC817-XX RFG	SOT-23	3K / 7" Reel

**Note:**

- "xx" is device code "16", "25" and "40"
- "G" means green compound (halogen free)

**CHARACTERISTICS CURVES**

( $T_A = 25^\circ\text{C}$  unless otherwise noted)

**Fig.1 Typical Pulsed Current Gain VS. Collector Current**

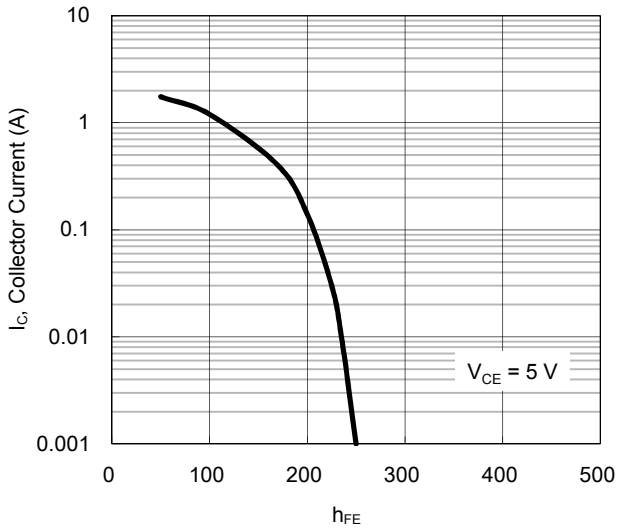

**Fig. 2 Collector-Emitter Saturation Voltage VS. Collector Current**

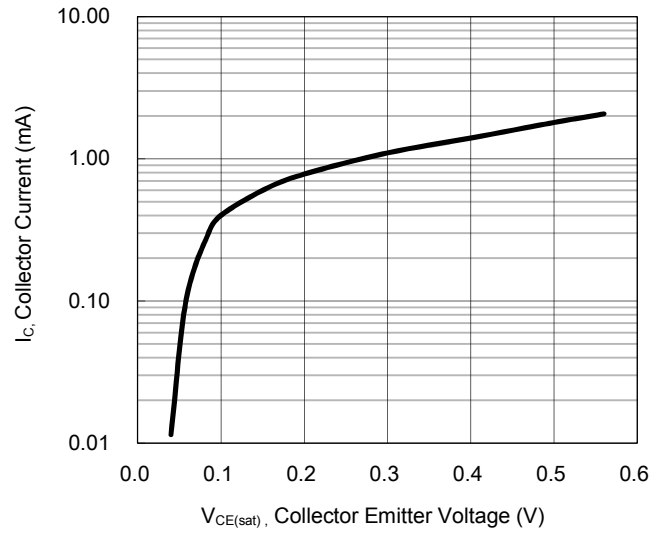

**Fig.3 Base-Emitter Saturation Voltage VS. Collector Current**

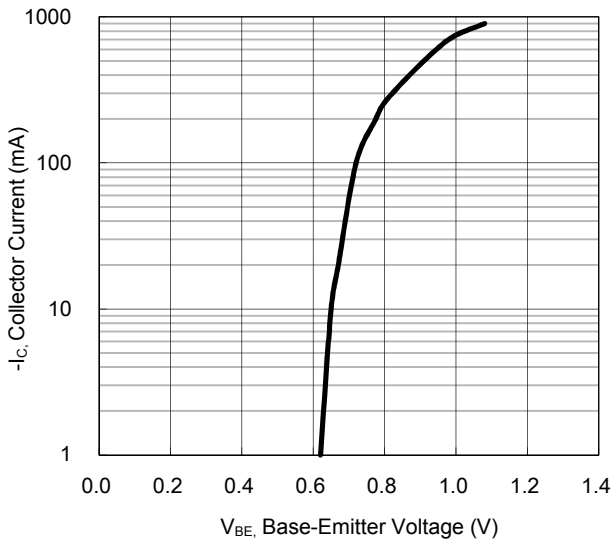

**Fig.4 Base-Emitter On Voltage VS. Collector Current**

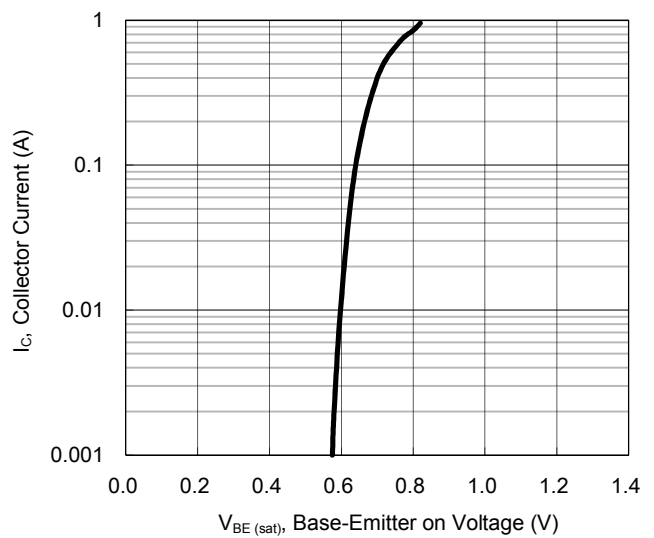

**CHARACTERISTICS CURVES**

( $T_A = 25^\circ\text{C}$  unless otherwise noted)

**Fig.5 Collector-Base Capacitance VS.  
Collector-Base Voltage**

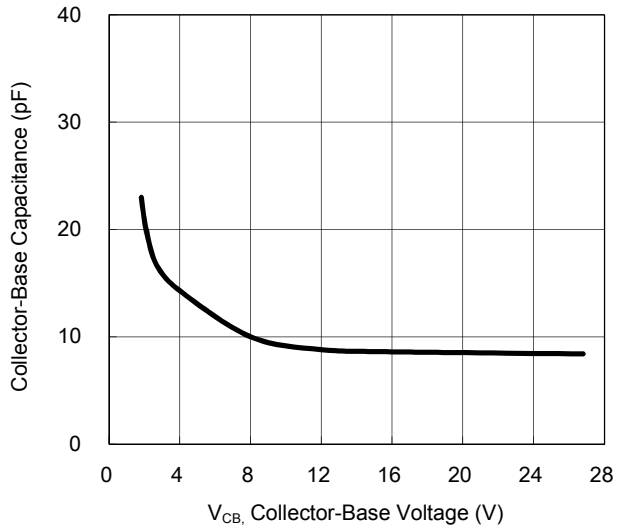

**PACKAGE OUTLINE DIMENSION**  
SOT-23

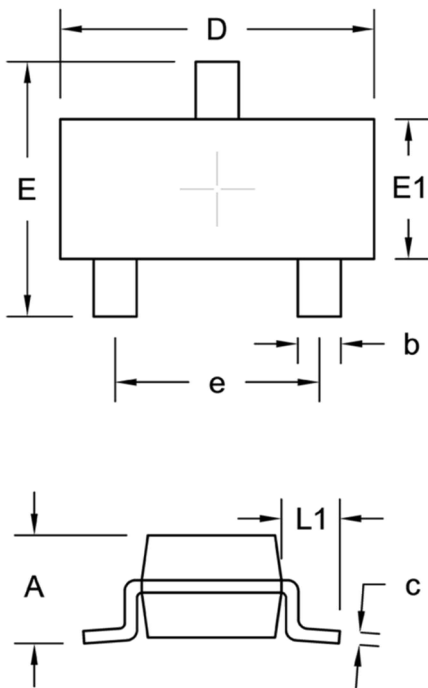

DIM.	Unit (mm)		Unit (inch)	
	Min.	Max.	Min.	Max.
A	0.89	1.12	0.035	0.044
b	0.30	0.50	0.012	0.020
c	0.08	0.20	0.003	0.008
D	2.80	3.04	0.110	0.120
E	2.10	2.64	0.083	0.104
E1	1.20	1.40	0.047	0.055
e	1.90 BSC		0.075 BSC	
L1	0.54 REF.		0.021 REF.	

**SUGGESTED PAD LAYOUT**

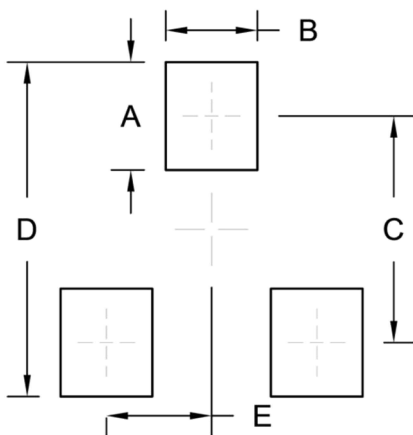

Symbol	Unit (mm)	Unit (inch)
A	1.00	0.039
B	0.85	0.033
C	2.10	0.083
D	3.10	0.122
E	0.98	0.039